

Link do produktu: <https://nova-sklep.pl/r110414-zlaczka-prosta-4-r14-bspt-p-97.html>



R110414 ZŁACZKA PROSTA 4 R1/4 BSPT

Cena brutto	8,55 zł
Cena netto	6,95 zł
Dostępność	Dostępny
Czas wysyłki	24 godziny
Numer katalogowy	R110414
Producent	A.P.I. Italy

Opis produktu

PRZYŁĄCZE GWINTOWANE	R 1/4 BSPT (TEFLON)
ROZMIAR PRZEWODU	4 mm
RODZAJ GWINTU	Zewnętrzny
CIŚNIENIE ROBOCZE	0-12 bar
PODCIŚNIENIE -	750 mm Hg
ZAKRES TEMPERATUR	- 20°C + 70°C
MATERIAŁ KORPUSU	Mosiądz niklowany
USZCZELNIENIA	NBR
MEDIUM	Sprężone powietrze, gazy obojętne

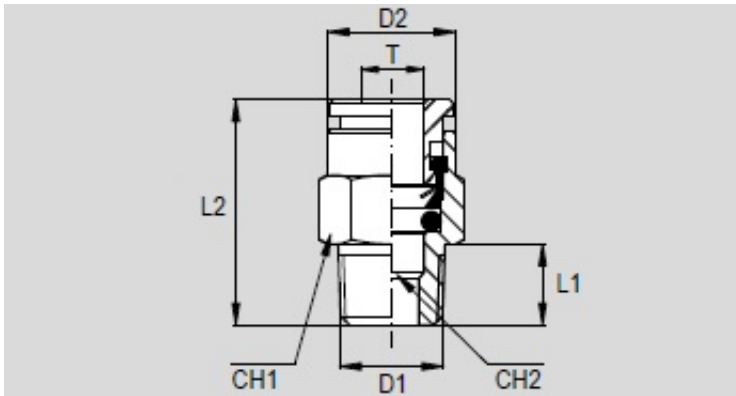

**NOVA Piotr Bitner Danuta Bitner Spółka Jawna**

ul. Andrzeja Struga 70

70-784 Szczecin















NIP: PL9551629566

KRS: 0000687374

tel. 609650020

www.nova-sklep.pl

info@nova-sklep.pl

Code	Item	T (ØTube)	D1	D2	L1	L2	CH1	CH2	Weight (g)
020001	 R 11 04 18	4	R1/8"	9	7,5	16	10	3	5,5
020002	 R 11 04 14	4	R1/4"	9	11	20,5	14	3	16,1
020005	 R 11 06 18	6	R1/8"	12	7,5	21	12	4	8,7
020006	 R 11 06 14	6	R1/4"	12	11	20,5	14	4	15,8
020573	 R 11 06 38	6	R3/8"	12	11,5	21	17	4	-
020007	 R 11 08 18	8	R1/8"	14	7,5	25	14	6	13,2
020008	 R 11 08 14	8	R1/4"	14	11	23,5	14	6	13,9
020009	 R 11 08 38	8	R3/8"	14	11,5	22,5	17	6	23,6
020574	R 11 08 12	8	R1/2"	13,9	14	25	22	6	-
020575	 R 11 10 18	10	R1/8"	15,9	7,5	28	16	6	-
020010	 R 11 10 14	10	R1/4"	16	11	30,5	16	8	20,2
020011	 R 11 10 38	10	R3/8"	16	11,5	24	17	8	20
020016	 R 11 10 12	10	R1/2"	16	14	27	22	8	47,5
020017	R 11 12 14	12	R1/4"	19	11	32	19	8	28,5
020012	 R 11 12 38	12	R3/8"	19	11,5	27,5	19	10	24,1
020013	 R 11 12 12	12	R1/2"	19	14	27,5	22	10	42,3
020014	R 11 14 38	14	R3/8"	22	11,5	35,5	22	10	40,1
020015	R 11 14 12	14	R1/2"	22	14	32,5	22	12	39,5



Czytaj więcej